



The Bose® Wave® Radio

Owner's Guide

January 4, 2002

AM189930_01_V.pdf

WARNING

To reduce the risk of fire or electric shock, do not expose the Wave® radio to rain or moisture.

CAUTION

To reduce the risk of shock, do not remove the cover. There are no user-serviceable parts inside. Refer servicing to authorized service personnel.

These CAUTION marks appear on the bottom of your Wave radio.



The lightning flash, with arrowhead symbol within an equilateral triangle, alerts the user to uninsulated dangerous voltage within the system enclosure which may cause electric shock.



The exclamation point, within an equilateral triangle as marked on the system, alerts the user to important operating and maintenance instructions in this owner's guide.

CAUTION
RISK OF ELECTRICAL SHOCK—DO NOT OPEN
TO PREVENT ELECTRICAL SHOCK, DO NOT REMOVE COVER. NO USER-SERVICEABLE PARTS INSIDE. REFER SERVICING TO QUALIFIED PERSONNEL.
TO PREVENT FIRE OR SHOCK HAZARD, DO NOT EXPOSE THIS UNIT TO RAIN OR MOISTURE.
AVIS
RISQUE DE CHOC ÉLECTRIQUE—NE PAS OUVRIR
AFIN DE PRÉVENIR UN CHOC ÉLECTRIQUE NE PAS ENLEVER LE COUVERCLE ARRIÈRE. IL NE SE TROUVE À L'INTÉRIEUR AUCUNE PIÈCE POUVANT ÊTRE RÉPARÉE PAR L'USAGER. S'ADRESSER À UN RÉPARATEUR COMPÉTENT.

CAUTION: To prevent electric shock, match wide blade of plug to wide slot, fully insert.

ATTENTION: Pour éviter les chocs électriques, introduire la lame la plus large de la fiche dans la borne correspondante de la prise et pousser jusqu'au fond.

This equipment has been tested and found to comply with the limits for a Class B digital device pursuant to Part 15 of the FCC Rules. These limits are designed to provide reasonable protection against harmful interference in a residential installation. This equipment generates, uses, and can radiate radio frequency energy and, if not installed and used in accordance with the instructions, may cause harmful interference to radio communications. However, this is no guarantee that interference will not occur in a particular installation. If this equipment does cause harmful interference to radio or television reception, which can be determined by turning the equipment off and on, you are encouraged to try to correct the interference by one or more of the following measures:

- Reorient or relocate the receiving antenna and the power cord.
- Increase the distance between the equipment and the receiver.
- Connect the equipment to an outlet on a different circuit than the one to which the receiver is connected.
- Consult the dealer or an experienced radio/TV technician for help.

Note:

This digital apparatus does not exceed the Class B limits for radio noise emissions from digital apparatus set out in the Radio Interference Regulations of the Canadian Department of Communications.

Le présent appareil numérique n'émet pas de bruits radioélectriques dépassant les limites applicables aux appareils numériques de la classe B prescrites dans le Règlement sur le brouillage radioélectrique édicté par le Ministère des communications du Canada.

Note:

Unauthorized modification of the receiver could void the user's authority to operate this equipment.

For your safety

1. **Read, Follow, And Save All Instructions** – Read and follow the complete safety and operating instructions in this owner’s guide before using the unit. Save this guide for future reference.
2. **Pay Attention To Warnings** – Observe all warnings on the unit and in the guide.
3. **Do Not Let Objects Or Liquid Enter The Unit** – Take care to prevent objects or liquids from entering this unit. Do not use near a bathtub, washbowl, kitchen sink, laundry tub, in a wet basement, near a swimming pool, or anywhere else that water is present. Clean only as directed on page 18.
4. **Maintain Proper Ventilation** – Place the unit so nothing interferes with its proper ventilation. Do not place on a bed, sofa, or similar surface that may block the ventilation openings. Do not put it in a bookcase or cabinet that may keep air from flowing through its ventilation openings.
5. **Avoid Excessive Heat** – Do not place the unit near heat sources such as radiators, stoves, or other appliances (including amplifiers) that produce heat.
6. **Use Proper Power Sources** – Plug the unit into a proper power supply, as described in the operating instructions or as marked on the unit. This unit has a polarized alternating current line plug (one blade is wider than the other). As a safety feature, the plug fits into the power outlet only one way. If you have trouble inserting it, reverse the plug. If it still does not fit, your outlet may be obsolete and needs to be replaced. Contact an electrician. Do not change the plug to defeat this safety feature.
7. **Protect The Power Cord** – Route all power cords so that they are not likely to be walked on or pinched. Pay particular attention to cords at plugs, at the point where the cord connects to the unit, and at outlets on the unit.
8. **Take Precautions When Unit Is Not In Use** – If the unit will not be used for an extended period, unplug from the outlet and remove the batteries.
9. **Be Careful With Carts And Stands** – Do not place this unit on an unstable cart, stand, tripod, bracket, or table. The unit may fall, causing serious injury to a person or damage to the unit. For advice on use of a particular cart, stand, tripod, bracket, or table, contact Bose® Corporation. Be careful when moving the unit and cart combination. Quick stops, excessive force, and uneven surfaces may cause it to overturn.
10. **Avoid Power Lines** – Do not install external antennas near overhead power lines or other electric light or power circuits, nor where an antenna can fall into such circuits or power lines.
11. **Ground All Outdoor Antennas** – If an external antenna or cable system is connected to this unit, be sure the antenna or cable system is grounded. This will provide some protection against voltage surges and built-up static charges.
Section 810 of the National Electrical Code ANSI/NFPA No. 70 provides information with respect to proper grounding of the mast and supporting structure, grounding of the lead-in wire to an antenna discharge unit, size of the grounding conductors, location of antenna-discharge unit, connection to grounding electrodes, and requirements for the ground electrode. Refer to the antenna grounding illustration.
12. **Obtain Authorized Service When It Is Indicated** – Do not attempt to service this unit yourself. All servicing should be provided by authorized service personnel when:
 - A. The power supply cord or the plug has been damaged, or
 - B. Objects have fallen or liquid has spilled into the unit, or
 - C. The unit has been exposed to rain, or
 - D. The unit does not appear to operate normally or exhibits a marked change in performance, or
 - E. The unit has been dropped or the cabinet damaged.

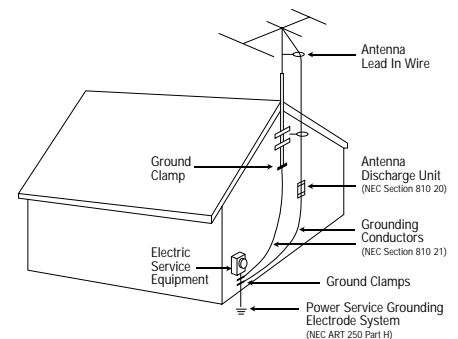

Note to CATV system installer:

This reminder calls the CATV system installer’s attention to Article 820-40 of the NEC (of USA) that provides guidelines for proper grounding. It specifies that the cable ground shall be connected to the grounding system of the building, as close to the point of cable entry as is practical.

Please read this owner's guide

The Bose® Wave® radio is carefully engineered to provide sound quality far beyond other radios. This guide will help you set up and operate your radio properly.

Where to find...

Safety Instructions

Cautions	3
For your safety	3

Setting Up

Unpack the carton	5
Install the batteries	5
Connect the power cord	6
The remote control	7

The Display

How to read the clock display	8
How to read the radio display	8
How to customize the display	9

Functions

Radio functions	10
Clock functions	12

Other Components

Connecting other components	16
Using other components	17

Product Information

Maintaining the Wave radio	18
For best radio reception	18
Features	18

Bose® Corporation

Warranty	19
Customer service	19

Unpack the carton

Carefully unpack the carton. Do not attempt to use the Wave® radio if any part appears damaged. Instead, repack the carton and notify Bose® or your authorized Bose dealer immediately.

It is best to place the radio across the room from where you will be listening. Place the radio on a table or other flat surface. Do not put it on a metal surface or table that could interfere with AM reception. If you will use the radio with your television or VCR, do not place it on top of the television. It may interfere with the picture quality.

Locate the power cord, AA batteries, remote control, and lithium battery.

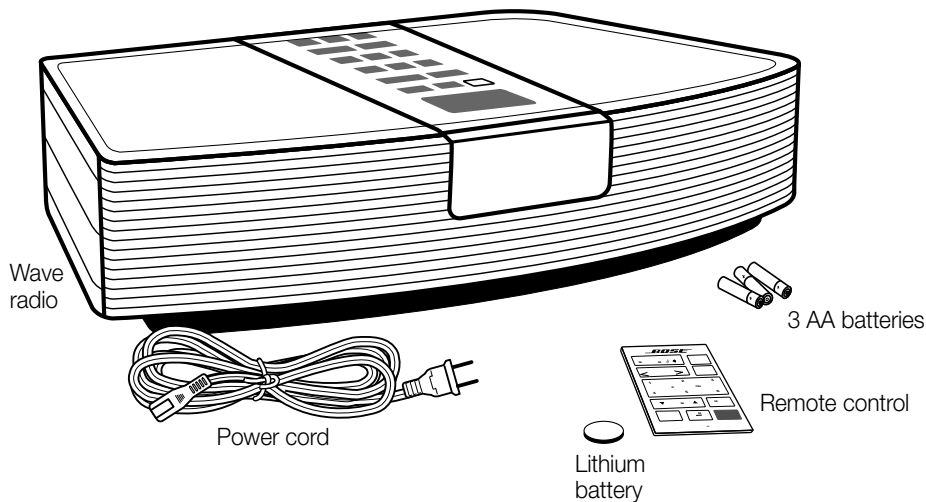

Figure 1

What comes with your radio.

- Wave radio
- Power cord
- Remote control
- Lithium battery
- AA batteries

Install the batteries

The Wave radio's three AA batteries maintain the memory and backup alarm system for up to a week during a power failure, or while the radio is unplugged. Operating without batteries leaves the memory unprotected, but will not harm the radio. Use AA batteries (IEC-R6 in Europe), available at many retail stores.

Note: The batteries will not power the radio or light the display.

1. Carefully turn your radio upside down (avoid scratching its top).
2. Locate the battery compartment on the bottom (see Figure 2).
3. Press the arrow on the cover to slide the compartment open.
4. Place the batteries inside, matching the + and - symbols with the symbols inside the compartment.
5. Slide the cover back and turn the radio right side up.

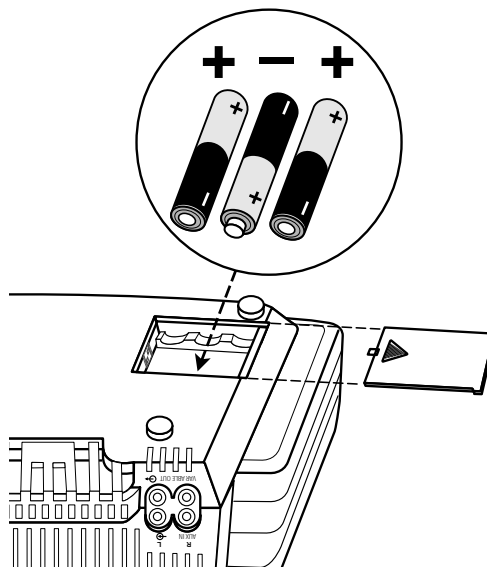

Figure 2

Installing the batteries.

Connect the power cord

1. Plug the small end of the power cord into the power jack on the back of your radio (see Figure 3). Line up the flat edge of the plug with the flat edge on the side of the jack.

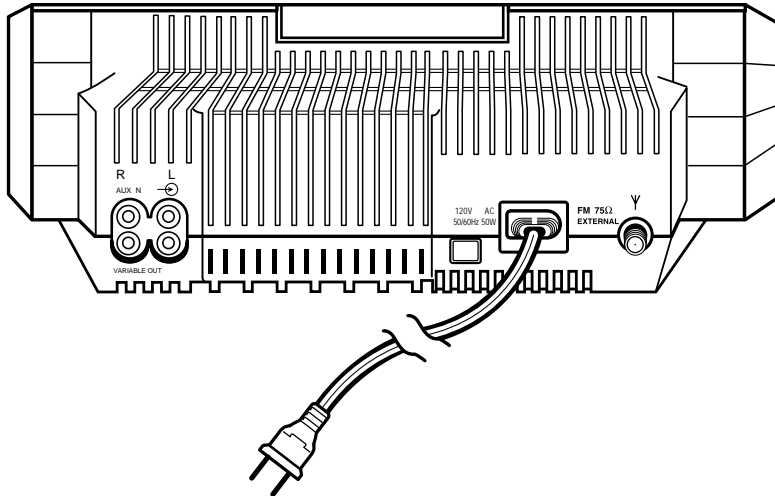

Figure 3

Connecting the power cord.

2. The FM antenna is built into the power cord. To improve FM reception, unwind the power cord completely.
3. Plug the other end of the power cord into an electric outlet.
4. The display panel lights and the time display begins flashing after the power is connected. Press the CLOCK SET button once to stop the flashing.

The remote control

Install the battery

Your Wave® radio remote control has a security lock to prevent children from reaching the small battery. Follow these steps to insert or remove the battery.

1. Place the remote control upside down and face down (as shown in Figure 4a).
2. Insert the tip of a pen into the small hole in the security lock (Figure 4a). If your pen does not have a long fine point, you can use a straightened paper clip instead.
3. Tilt the pen to push the lock in the direction shown by the arrow in Figure 4b. Push the lock until the battery compartment clicks open.

Note: If you have difficulty getting the lock to click open, use the pen to hold the lock to the side while pulling the battery carrier out. You can place a thin coin or other object in the battery carrier slot to help pull the battery carrier out.

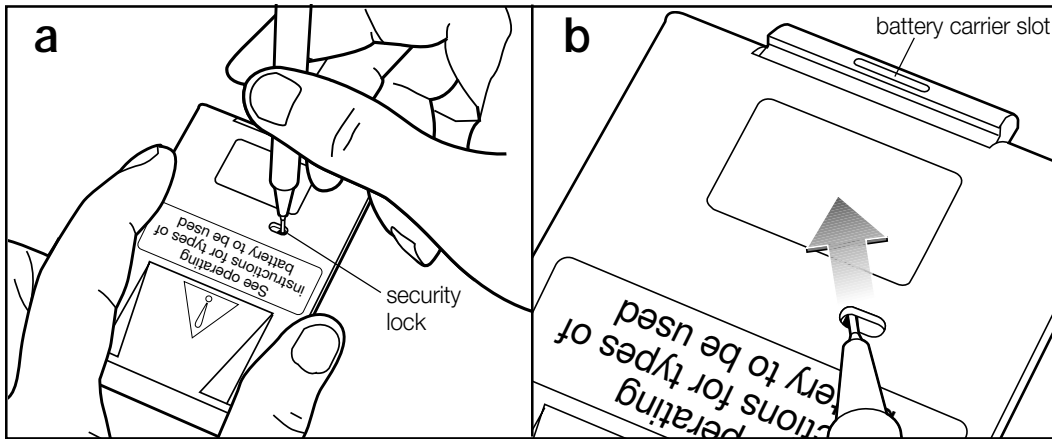

4. Slide the battery carrier out. Insert the battery into the battery carrier, with the + symbol facing up, as shown in Figure 5.
5. Slide the battery carrier closed. Do not force it. It automatically locks in place.

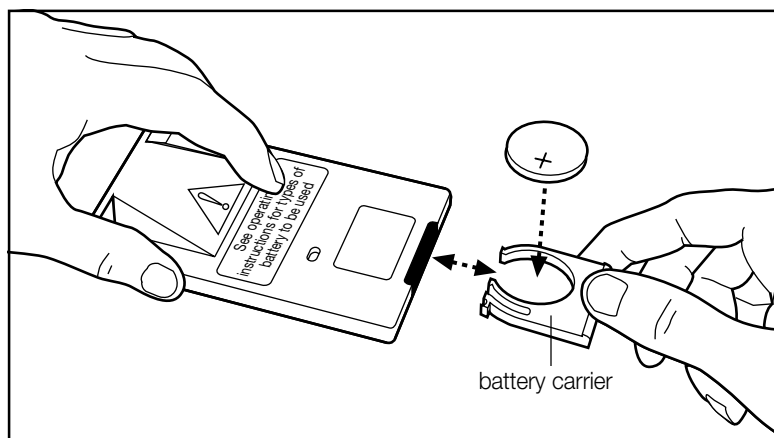

How to operate

Aim the remote control at your Wave radio. Use the remote keys in the same way you use the radio control panel. The remote normally works up to 20 feet in front of the radio, and 6 feet to either side. Replace the remote control battery when it stops operating, or its range seems reduced (normally every year or two).

Note:

Replace only with a Duracell, Eveready, Maxell, or Toshiba CR2032 or DL2032 lithium battery (available at most electronics stores). If you have difficulty finding a replacement battery, contact Bose® Customer Service (see phone numbers on the inside back cover).

Figure 4

Push the security lock toward the battery carrier slot, until the battery compartment lock clicks open.

Figure 5

Insert the battery with the + symbol facing up.

WARNING:

The remote control battery may cause a fire or chemical burn if mishandled. Keep it away from children. Do not recharge, disassemble, heat above 100°C (212°F), or incinerate. Dispose of used battery promptly. Replace with a battery of the type and model mentioned in the note above. Using another battery may cause a fire or explosion.

How to read the clock display

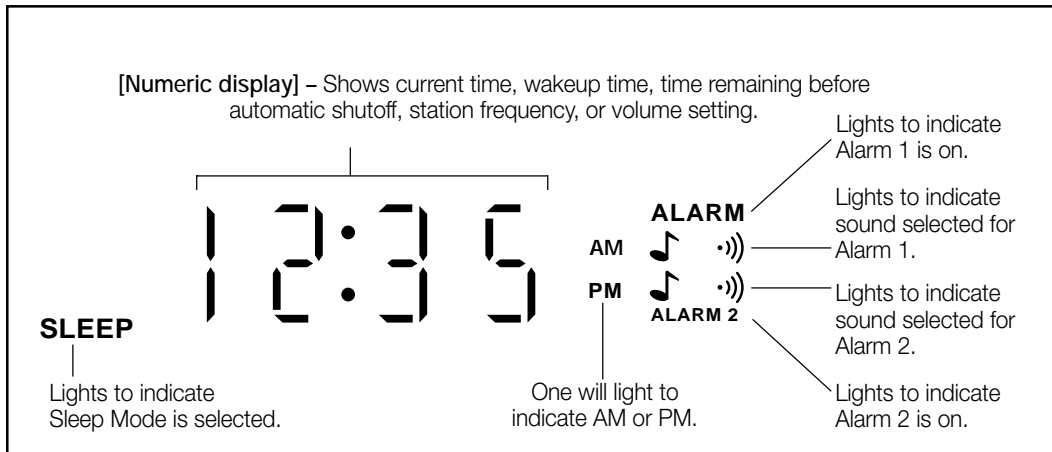

Figure 6A

The clock display.

Note:

The display automatically adjusts as the light in your room changes. In normal lighting the display is bright. In darker rooms the display dims.

How to read the radio display

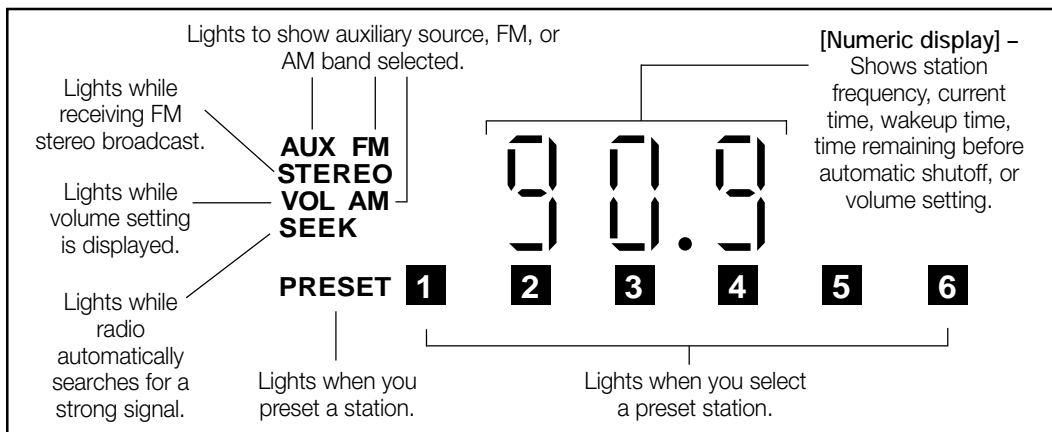





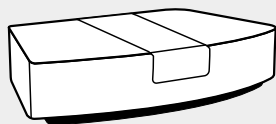

Figure 6B

The radio display.

How to customize the display

Function	Keys	Action
AM/PM (12 hour) or Military (24 hour) time		Press ON/OFF once to turn your Wave® radio off.
	 and 	Hold down CLOCK SET and press ON/OFF to switch between AM/PM (12 HR) or military (24 HR) formats.
Clock or radio mode	 	<p>In clock mode, the display shows the time while the radio is on; in radio mode, the display shows the radio station that is selected.</p> <p>With the radio turned on, hold down the CLOCK SET button and press the AM/FM button to switch between clock and radio modes.</p>









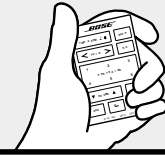



Radio Control Operation

	<p>To turn on/off</p>	<p>Press ON/OFF once to turn on (automatically selects the last source played) or to turn off. Selecting any preset also turns the radio on.</p>
		<p>Press AM/FM to turn the radio on. Press again to switch between FM and AM.</p>
		<p>Press AUX once to listen to a component connected to the AUX IN jacks. (This does not turn on the component).</p>
	<p>To shut off automatically</p>	<p>Press SLEEP/SNOOZE to set automatic shutoff. The display shows 75 minutes. Press again, or press and hold, to reduce the time until shutoff to 60, 45, 30, 15, 10, 5, or 0 minutes.</p>
		<p>Press ON/OFF to turn off the radio before automatic shutoff.</p>
	<p>To select AM or FM</p>	<p>If the radio is off or in AUX mode, press AM/FM to select the radio. Press again to select AM or FM.</p>
	<p>To adjust volume</p>	<p>While the radio is on or off, press either VOLUME button and hold to reset the volume. The display shows the volume level from 0 (soft) to 99 (loud).</p>
	<p>To display the station</p>	<p>If the display is in clock mode and the radio is on, press both TUNING buttons simultaneously to display the current station for several seconds.</p>
	<p>To tune in a station</p>	<p>Press and hold either TUNING button until the desired station is selected.</p>
	<p>To seek a station</p>	<p>Press and hold either TUNING button until you hear a beep. Then release to find the next strong signal. Turn the volume up, if necessary, to hear the beep.</p>
	<p>To preset up to 6 AM and 6 FM stations</p>	<p>Use the TUNING buttons to find the desired station. Then, hold down any PRESET button until you hear a beep. The station is now preset to that button.</p>
	<p>To tune in a preset</p>	<p>Choose AM or FM. Press the PRESET button for the station you want.</p>

Remote Control Operation

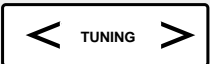
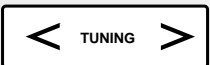
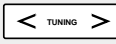
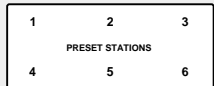

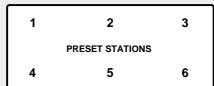
To turn on/off	Press ON/OFF once to turn on (automatically selects the last source played) or to turn off. Selecting any preset also turns the radio on.	
	Press AM/FM to turn the radio on. Press again to switch between FM and AM.	
	Press AUX once to listen to a component connected to the AUX IN jacks. (This does not turn on the component).	
To shut off automatically	<p>Press SLEEP to set automatic shutoff. The display shows 75 minutes. Press again, or press and hold, to reduce the time until shutoff to 60, 45, 30, 15, 10, 5, or 0 minutes.</p> <p>Press ON/OFF to turn off the radio before automatic shutoff.</p>	 
To select AM or FM	If the radio is off or in AUX mode, press AM/FM to select the radio. Press again to select AM or FM.	
To adjust volume	<p>While the radio is on or off, press either VOLUME button and hold to reset the volume. The display shows the volume level from 0 (soft) to 99 (loud). Press MUTE to silence the radio. Press again to restore volume.</p>	 
To display the station	If the display is in clock mode and the radio is on, press STA.	
To tune in a station	Press and hold either TUNING button until the desired station is selected.	
To seek a station	Press and hold either TUNING button until you hear a beep. Then release to find the next strong signal. Turn the volume up, if necessary, to hear the beep.	
To preset up to 6 AM and 6 FM stations	Use the TUNING buttons to tune to the desired station. Then hold down any PRESET button until you hear a beep. The station is now preset to that button.	 
To tune in a preset	Choose AM or FM. Press the PRESET button for the station you want.	 

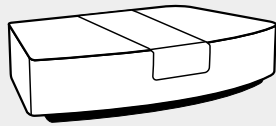

Radio Control Operation

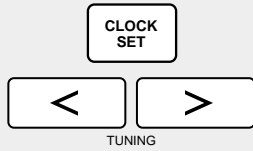

To set the clock

While holding down the CLOCK SET button, press either TUNING button. The time display changes slowly at first, then more quickly. It stops when you release the TUNING button.

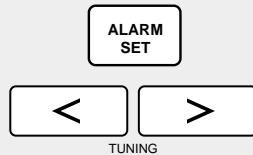

To set Alarm 1 wake up time and alarm sound

Note: You can set the alarm with the radio on or off. Hold down ALARM SET and press either TUNING button. The time display changes slowly at first, then more quickly. It stops when you release any button.



To change the Alarm 1 sound, press ALARM MODE.

For tone only, press until the (·)) indicator lights. When the alarm goes off, the tone volume gradually increases to your preset level.

For radio only, press until the (♪) indicator lights. When the alarm goes off, the radio volume gradually increases to your preset level.

For tone and radio, press until both indicators (♪ ·)) light. When the alarm goes off, the tone sounds. After you press SLEEP/SNOOZE, the radio turns on.

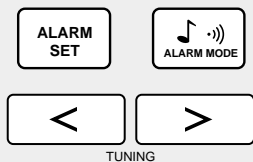

To set Alarm 2 wake up time and alarm sound

Note: You can set the alarm with the radio on or off. Hold down ALARM SET and press ALARM MODE. The Alarm 2 indicator flashes. You now have 10 seconds to begin setting Alarm 2.

Note: The Alarm 2 indicator must be flashing while setting Alarm 2 wake up time or sound.

To set Alarm 2 wake up time, hold down ALARM SET and press either TUNING button.



To change Alarm 2 sound, press ALARM MODE while the Alarm 2 indicator flashes.

For tone only, press until the (·)) indicator lights. When the alarm goes off, the tone volume gradually increases to your preset level.

For radio only, press until the (♪) indicator lights. When the alarm goes off, the radio volume gradually increases to your preset level.

For tone and radio, press until both indicators (♪ ·)) light. When the alarm goes off, the tone sounds. After you press SLEEP/SNOOZE, the radio turns on.

Note: The Alarm 2 indicator continues flashing for 10 seconds after wake up time and sound are set.

Remote Control Operation

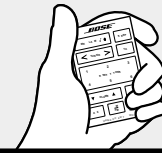

To set the clock

You cannot set the clock with the remote control.

To set Alarm 1 wake up time and alarm sound

Note: You can set the alarm with the radio on or off.

Press TIME. The alarm indicator begins flashing.

Press either TUNING button. The time display changes slowly at first, then more quickly. It stops when you release any button.

Press TIME to return the display to the current time.

To change the Alarm 1 sound, press .

For tone only, press until the () indicator lights. When the alarm goes off, the tone volume gradually increases to your preset level.

For radio only, press until the () indicator lights. When the alarm goes off, the radio volume gradually increases to your preset level.

For tone and radio, press until both indicators () light. When the alarm goes off, the tone sounds. After you press SLEEP, the radio turns on.

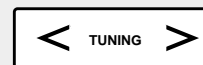

To set Alarm 2 wake up time and alarm sound

Note: You can set the alarm with the radio on or off.

Press TIME, then . The Alarm 2 indicator flashes. You now have 10 seconds to begin setting Alarm 2.

Note: The Alarm 2 indicator must be flashing while setting Alarm 2 wake up time or sound.

To set Alarm 2 wake up time, press either TUNING button. Press TIME to return to the regular display.

To change Alarm 2 sound, press TIME to return to regular display. Then press  while the Alarm 2 indicator flashes.

For tone only, press until the () indicator lights. When the alarm goes off, the tone volume gradually increases to your preset level.

For radio only, press until the () indicator lights. When the alarm goes off, the radio volume gradually increases to your preset level.

For tone and radio, press until both indicators () light. When the alarm goes off, the tone sounds. After you press SLEEP, the radio turns on.

Note: The Alarm 2 indicator continues flashing for 10 seconds after wake up time and sound are set.



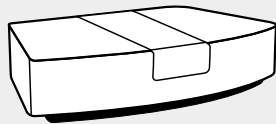







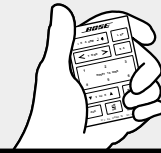

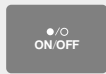















Radio Control Operation

	<p>To use Auto Reset</p>	<p>While the alarm sounds, press ON/OFF once. The alarm stops and resets to go off at the same time tomorrow. If you do not turn off the alarm, it continues to sound for 30 minutes. Then it stops and resets to go off at the same time tomorrow.</p>
	<p>To check Alarm 1</p>	<p>Press ALARM SET. The display shows the wake up time for Alarm 1.</p>
	<p>To check Alarm 2</p>	<p>Simultaneously press both ALARM SET and ALARM MODE. The display shows the wake up time for Alarm 2.</p>
<p>VOLUME</p>	<p>To set the volume of the alarm</p>	<p>For the radio (🎵), use the VOLUME buttons to set the volume. For tone (🔊), choose the alarm sound (see page 12). Set the alarm to go off. When the alarm sounds, press either VOLUME button to adjust the volume.</p>
	<p>Press ON/OFF to silence the alarm. This automatically resets the alarm to repeat tomorrow.</p>	
	<p>To snooze</p>	<p>When the alarm is in tone (🔊) or radio (🎵) mode, press SLEEP/SNOOZE to pause the alarm for ten minutes. When the alarm is in tone and radio (🎵 🔊) mode, press SLEEP/SNOOZE to pause the tone and hear the radio. The tone sounds again in ten minutes. Press again to silence the radio. The alarm indicator flashes while paused.</p>
	<p>To stop the alarm</p>	<p>Press ON/OFF once. The indicators remain lit. The alarm repeats tomorrow.</p>
	<p>To disable Alarm 1</p>	<p>To turn off the alarm function, press ALARM MODE until the (🎵) and (🔊) indicators do not appear on the display. The alarm must be reset for next use.</p>
	<p>To disable Alarm 2</p>	<p>Hold down ALARM SET and press ALARM MODE. Alarm 2 flashes on the display. Release ALARM SET. Press ALARM MODE until the (🎵) and (🔊) indicators no longer appear.</p>
<p>PRESET STATIONS</p>	<p>To wake to your favorite station</p>	<p>Simultaneously press ALARM SET and any PRESET button. The preset indicator and the station frequency flash on the display. Release the ALARM SET button. Alarm 1 plays this station until you reset the alarm.</p>
	<p>Alarm operation during a power failure</p>	<p>Press ON/OFF to silence. Backup batteries run the alarm for approximately a week during power failure. To conserve power, only the tone sounds, even if radio is selected. Normal operation resumes when power is restored. Batteries should be replaced after an extended power failure.</p>

Remote Control Operation



<p>To use Auto Reset</p>	<p>While the alarm sounds, press ON/OFF once. The alarm stops and resets to go off at the same time tomorrow. If you do not turn off the alarm, it continues to sound for 30 minutes. Then it stops and resets to go off at the same time tomorrow.</p>	
<p>To check Alarm 1</p>	<p>Press TIME on your remote control. The display shows the wake up time for Alarm 1. Press TIME again to return to normal display.</p>	
<p>To check Alarm 2</p>	<p>Press TIME. Then press . The display shows the wake up time for Alarm 2. Press TIME. Then press . The normal display returns.</p>	
<p>To set the volume of the alarm</p>	<p>For the radio () , use the VOLUME buttons to set the volume. For tone (), choose the alarm sound (see page 13). Set the alarm to go off. When alarm sounds, press either VOLUME button to adjust the volume. Press ON/OFF to silence the alarm. This automatically resets the alarm to repeat tomorrow.</p>	 
<p>To snooze</p>	<p>When the alarm is in tone () or radio () mode, press SLEEP to pause the alarm for ten minutes. When the alarm is in tone and radio () mode, press SLEEP on your remote control to pause the tone and hear the radio. The tone sounds again in ten minutes. Press again to silence the radio. The alarm indicator flashes while paused.</p>	
<p>To stop the alarm</p>	<p>Press ON/OFF once. The indicators remain lit. The alarm repeats tomorrow.</p>	
<p>To disable Alarm 1</p>	<p>To turn off the alarm function, press  until the () and () indicators do not appear on the display. The alarm must be reset for next use.</p>	
<p>To disable Alarm 2</p>	<p>Press TIME. Then press . Alarm 2 flashes. Press TIME again. Press  until the () and () indicators no longer appear on the display.</p>	
<p>To wake to your favorite station</p>	<p>Use the radio control panel to select this feature.</p>	
<p>Alarm operation during a power failure</p>	<p>Press ON/OFF to silence. Backup batteries run the alarm for approximately a week during power failure. To conserve power, only the tone sounds, even if radio is selected. Normal operation resumes when power is restored. Batteries should be replaced after an extended power failure.</p>	

Connecting other components

Use your Wave® radio to improve the sound of a CD player, cassette player, or TV. You can also use your radio as extension speakers for the Bose® Lifestyle® music system. Connect one of these components to the right and left AUX IN jacks. Or add powered Bose speakers connected to the right and left VARIABLE OUT jacks. Audio cables for these connections are available at electronics stores, or by calling Bose.

Most audio cables are color coded. Match the red plugs to the right (red) jack and the black or white plugs to the left (white) jack (see Figure 7).

Connecting components or speakers to the VARIABLE OUT jacks will shut off the radio's speakers.

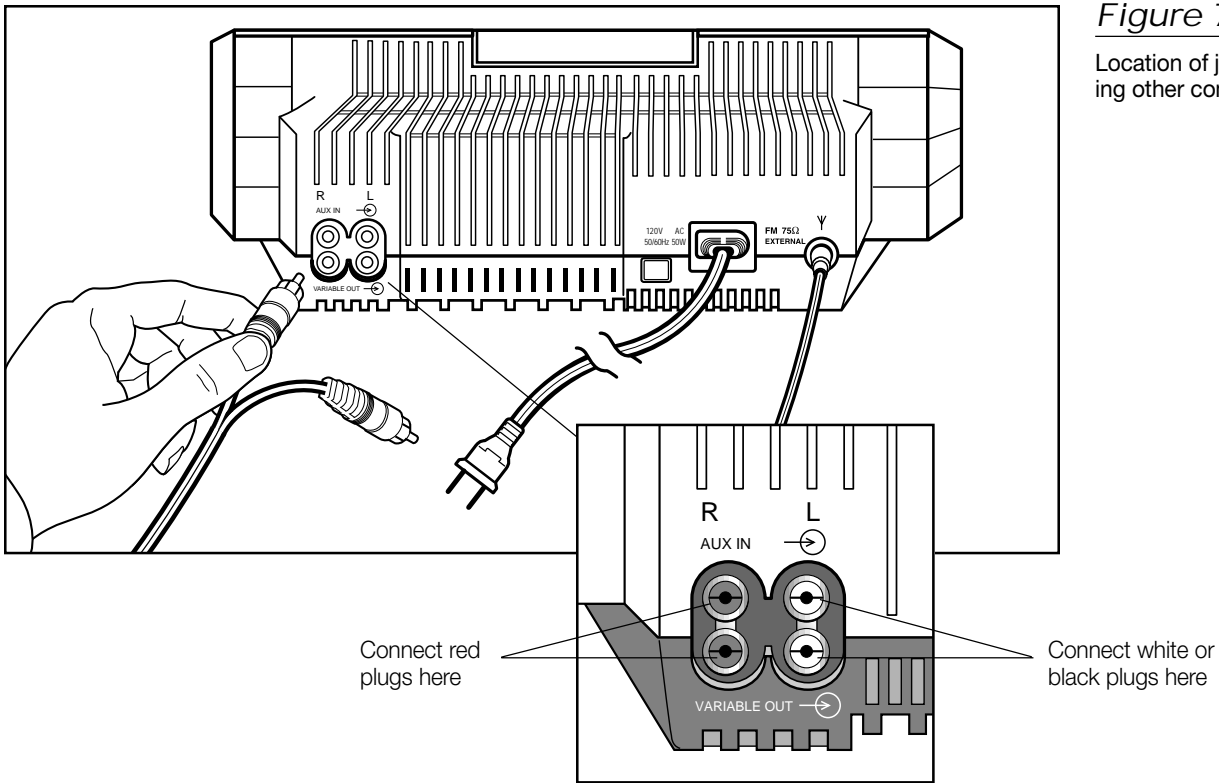

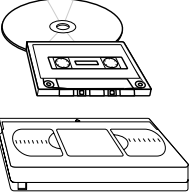

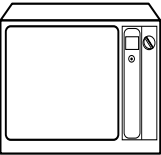





Figure 7

Location of jacks to use in connecting other components.

Component	Cable	Connection at component	Connection at Wave® radio	Note
Portable CD or tape player 	One miniplug-to-stereo audio cable 	Headphone jack (set the headphone volume control to 7).	AUX IN jacks	
CD player, tape deck, or VCR 	One stereo audio cable 	Audio output jacks If there are two sets of outputs, use the fixed outputs.	AUX IN jacks	Recording from your Wave radio is not recommended because connections to the VARIABLE OUT jacks shut off the radio speakers, preventing you from monitoring the recording volume.
Television 	TVs with stereo output jacks need a standard RCA cord. TVs with single (mono) audio output jacks use a standard Y adapter. TVs with earplug outlets may need a special earplug adapter.	Audio output jacks If there are two sets of outputs, use the fixed outputs.	AUX IN jacks	To make sure the sound seems to come from the screen, place the Wave radio close to the TV. To prevent interference with the TV picture, do not place the Wave radio directly on top of the TV.
Bose® Lifestyle® music system 	25 to 100 foot stereo cable with male-to-male RCA plugs. 	TAPE (REC) jacks	AUX IN jacks	
Powered Bose speakers 	Use the audio-input cables that came with your speakers.	Speaker system input as described in the speaker owner's manual.	VARIABLE OUT jacks	Some Bose audio-input cables have three connectors at each end. Use only the two connectors that look alike. DO NOT INSERT THE THIRD CONNECTOR into the speaker's SYSTEM CONTROL jack.

Using other components

Choose your CD player, tape player, or other auxiliary source by pressing the AUX key. Adjust the listening volume with the VOLUME keys. Control all other functions at the source, referring to its owner's manual, if necessary. Control your auxiliary powered speakers from the Wave radio. If these speakers have a volume control, you may use it.

Maintaining the Wave® radio

The only necessary maintenance is periodic battery replacement and cleaning.

Replace the batteries

To protect your Wave radio's memory and backup alarm system, replace the batteries every year and when you have an extended power loss. Dead batteries may leak and cause damage. Do not unplug your Wave radio from the power outlet while replacing the batteries. If you do unplug it, you will need to reset the clock, alarm settings, and station presets. For further information on replacing batteries, see "Install the batteries" on page 5.

For information on replacing the remote control battery, see "Install the battery" on page 7.

How to clean

Use only a cloth to clean the outside of the Wave radio. Do not use any solvents, chemicals, or cleaning solutions containing alcohol, ammonia, or abrasives. Do not allow liquids to spill into any openings on the radio. If necessary, you may use a soft-bristled attachment to gently vacuum the front of the radio.

For best radio reception...

The Wave radio has an internal antenna. You may adjust the antenna by turning the radio slightly.

You may adjust the FM antenna by moving the power cord. If you still have problems with FM reception, you may need an external antenna. Call Bose® Customer Service to request one.

Features

- Acoustic Wave® speaker technology provides deep, full bass from a small enclosure.
- High performance stereo tuner allows 6 AM and 6 FM station presets.
- Automatic protection circuitry prevents speaker damage from excessive volume.
- Dual independent alarms let you set two wakeup times.
- Credit card-size remote offers convenient operation of the radio and clock functions.

Size

Dimensions

- 4.5"H x 14"W x 8"D (11.4 x 35.6 x 20.3 cm)

Weight

- 7 lb (3.2 kg)

Power rating

- USA/Canada: 120VAC~ 50/60 Hz 50W

Warranty period

The Bose Wave® radio is covered by a limited 1-year transferable warranty. Details of the warranty are provided on the warranty card that came with your radio. Please fill out the information section on the card and mail it to Bose.

Customer service

For additional help in solving problems, contact Bose customer service.

USA

1-800-637-8781 Monday through Friday, 8:00 a.m. to 9 p.m. ET

Canada

1-800-444-BOSE (1-800-444-2673) Monday through Friday, 9 a.m. to 5 p.m. ET



BOSE[®]
Better sound through research[®]

© 1996 Bose Corporation
The Mountain, Framingham, MA 01701-9168 USA
JN97832 PN189930 Rev.01 AM189930 Rev.01